

♡(ハート)をかきましょう。



なまえ





なまえ

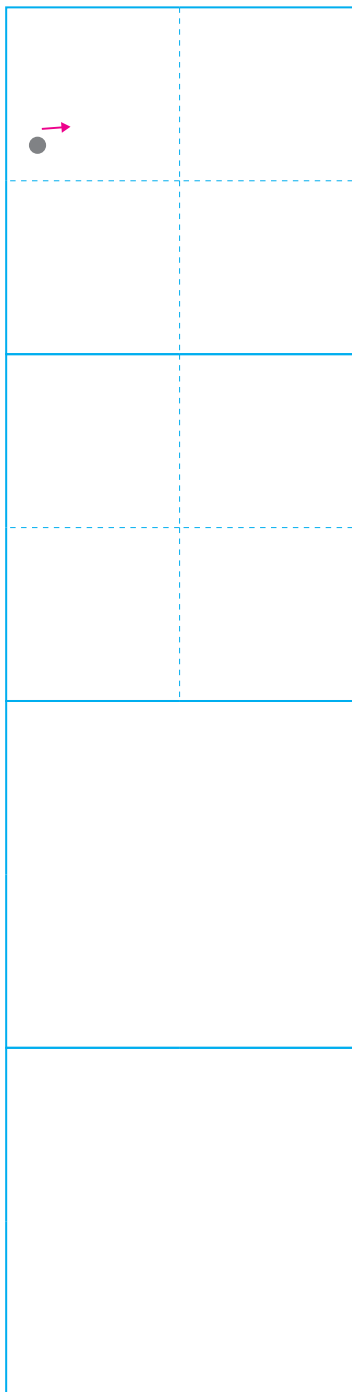
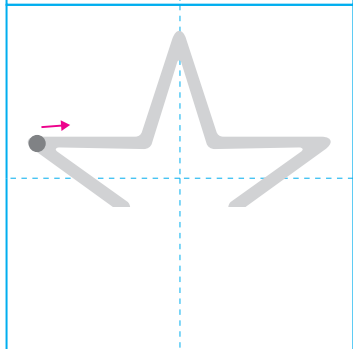
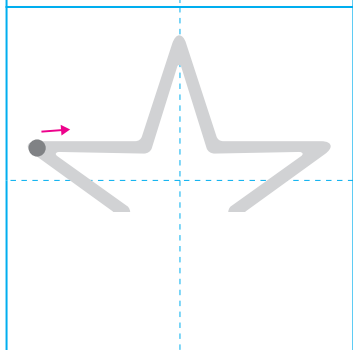
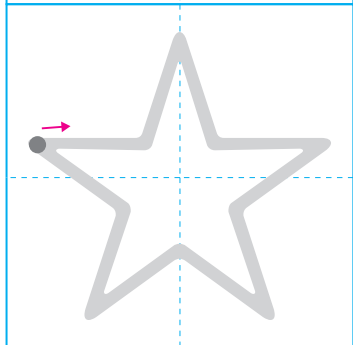
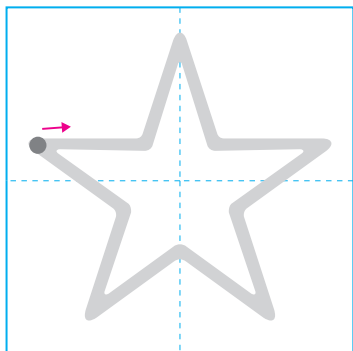
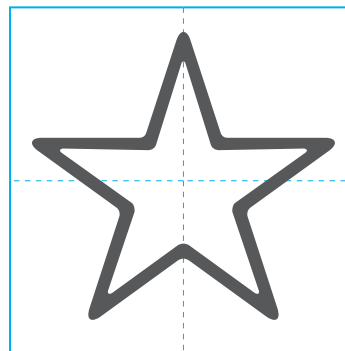

☆(ほし)をかきましょう。

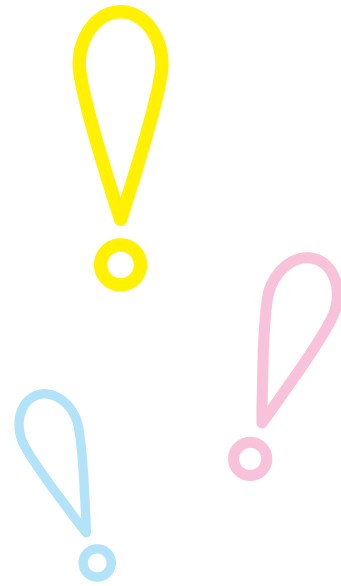
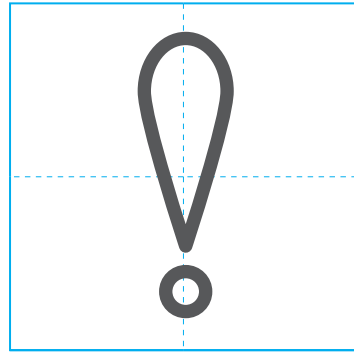
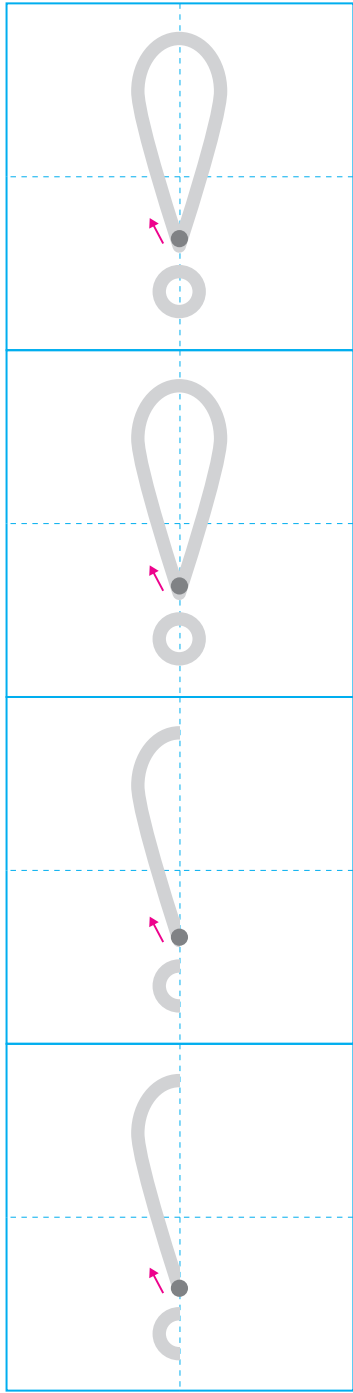
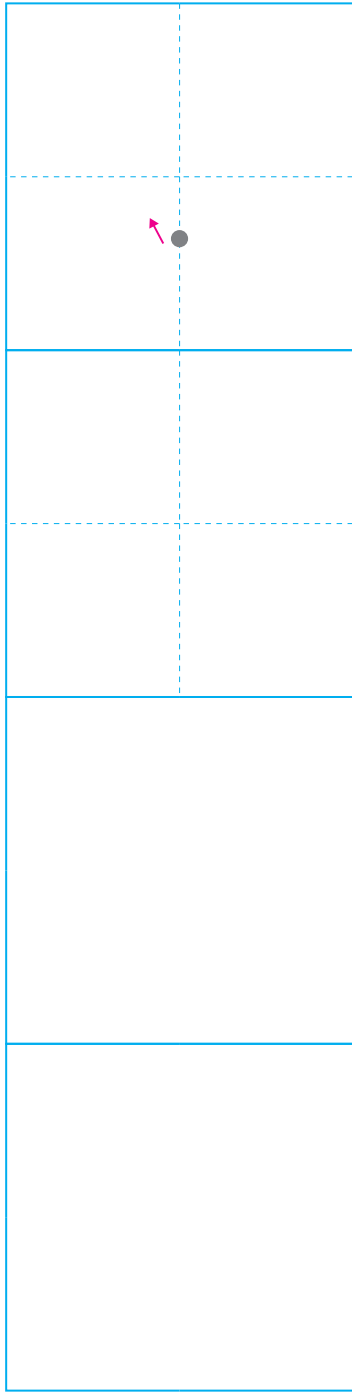



 びっくりマーク() を かきましよう。



なまえ

● ↑	

● ↑	
● ↑	
● ↑	
● ↑	

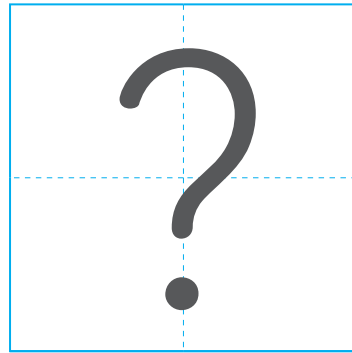

？(はてなマーク)をかきましょう。



なまえ



なまえ



◇(ダイヤ)をかきましょう。

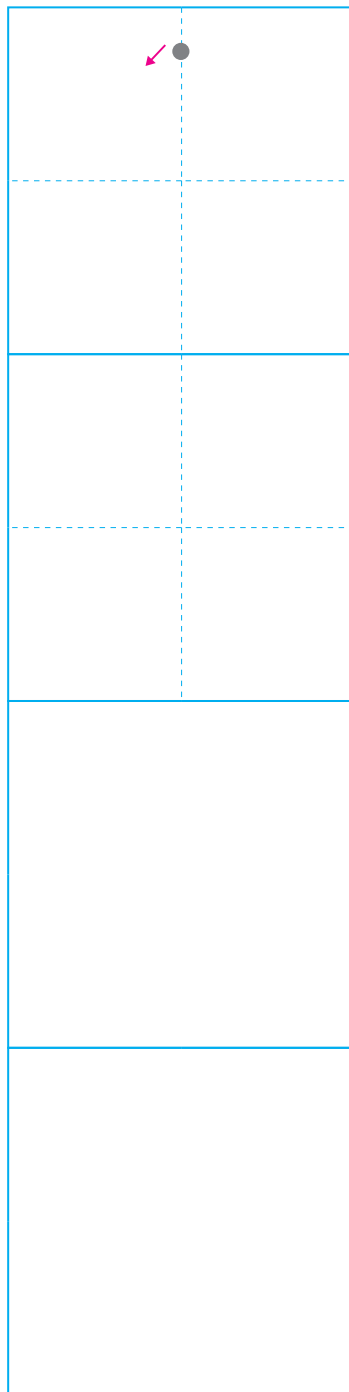
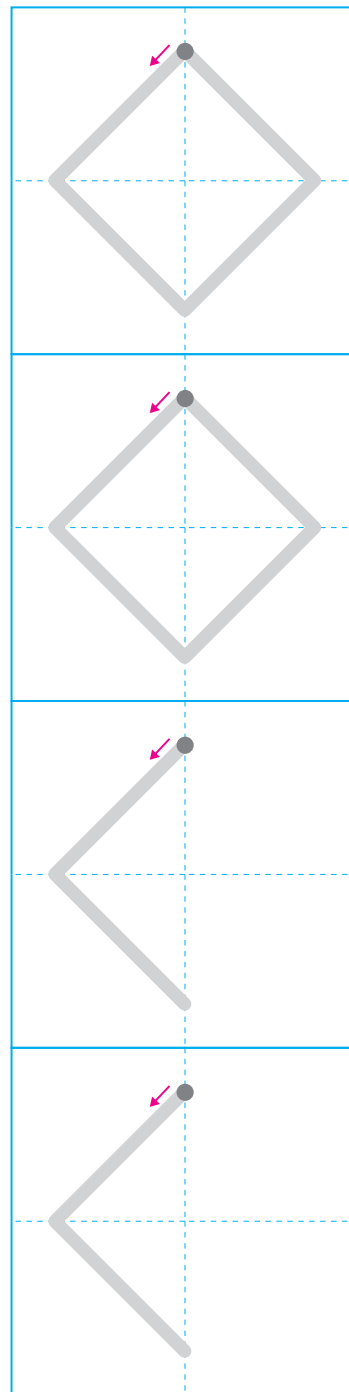
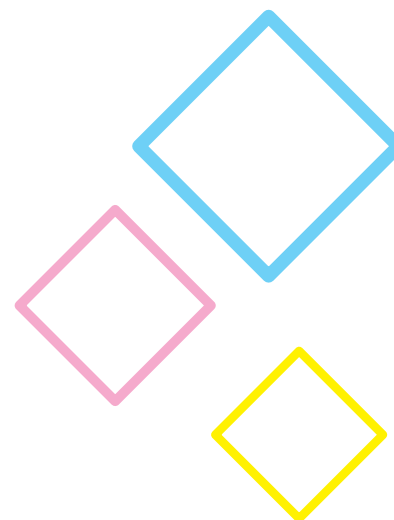
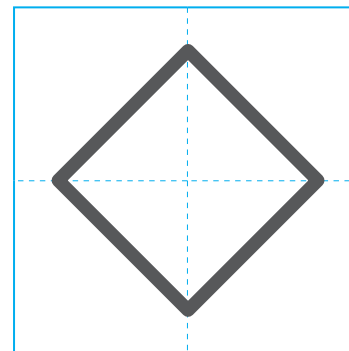



なまえ



♠(スペード)をかきましょう。

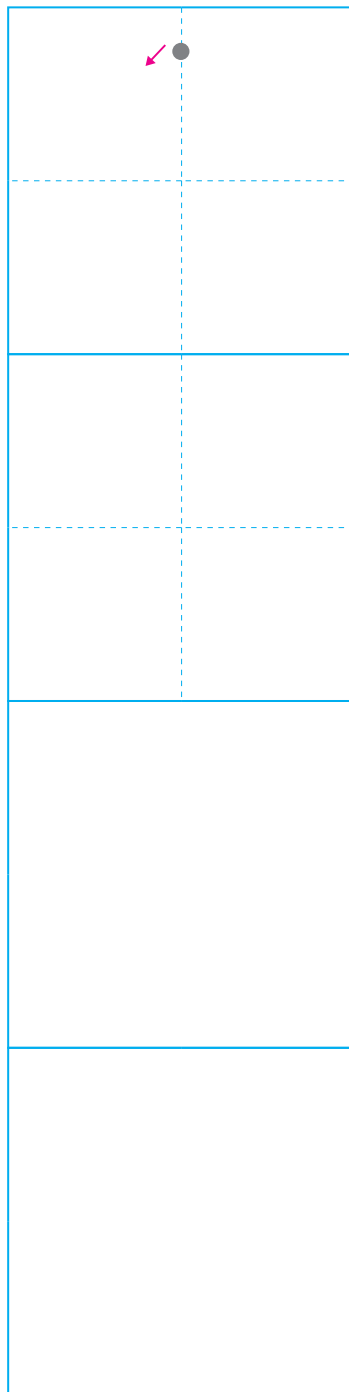
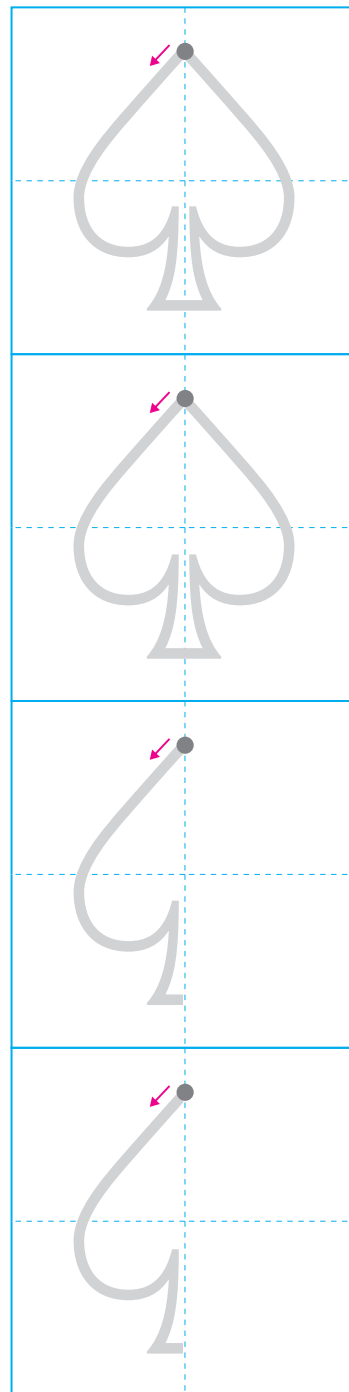
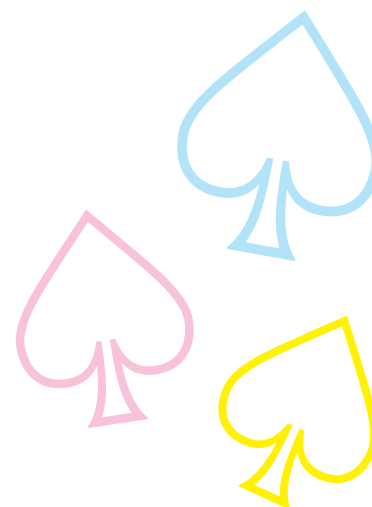
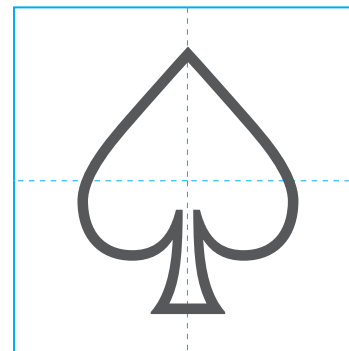



なまえ



♣(クローバー)をかきましょう。

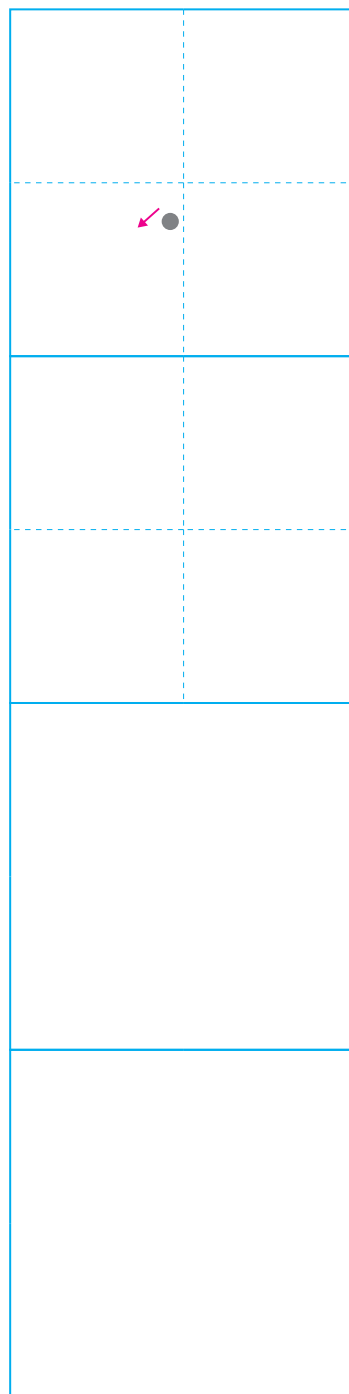
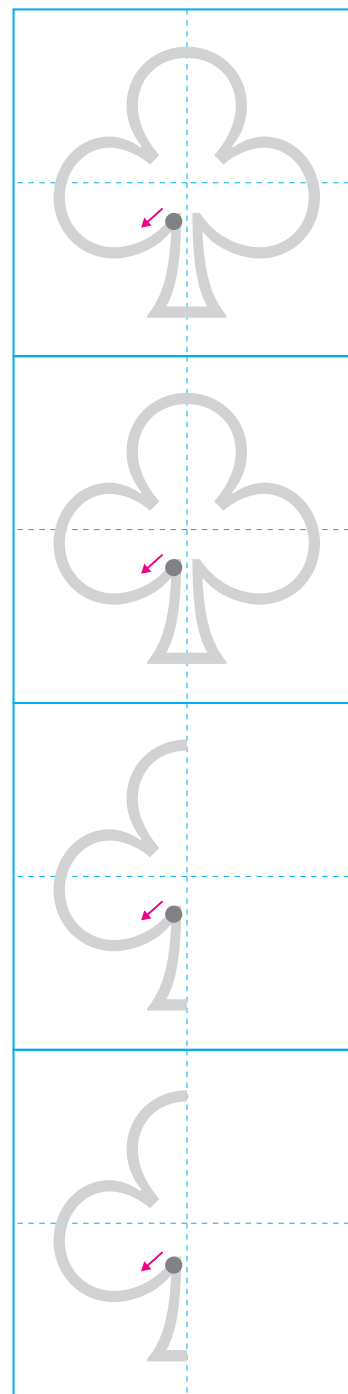
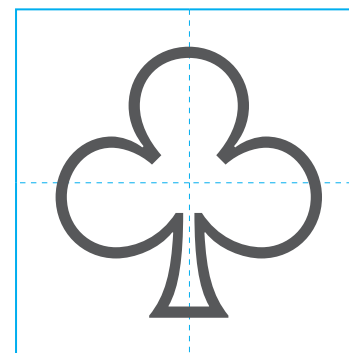
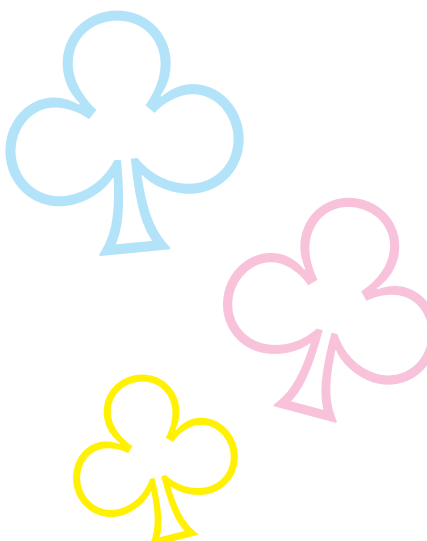



なまえ



「や」() やじるし () を かきましよう。

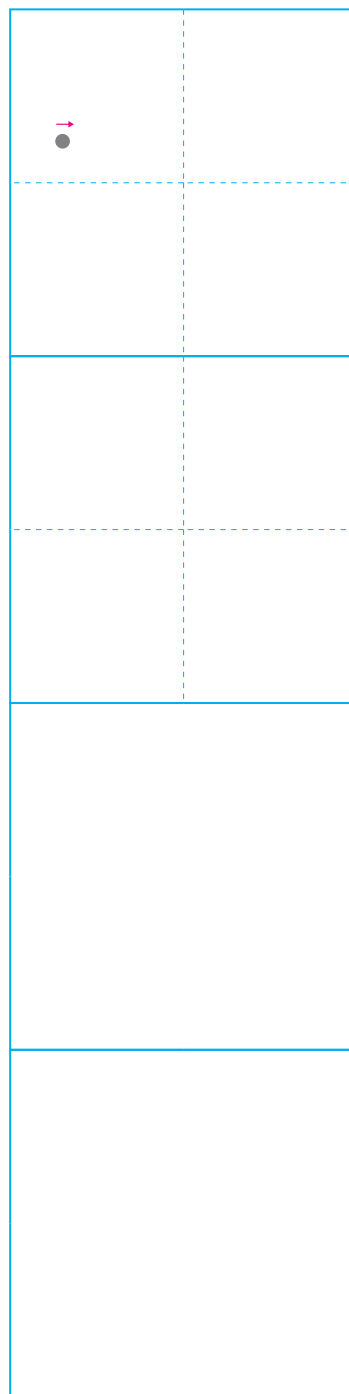
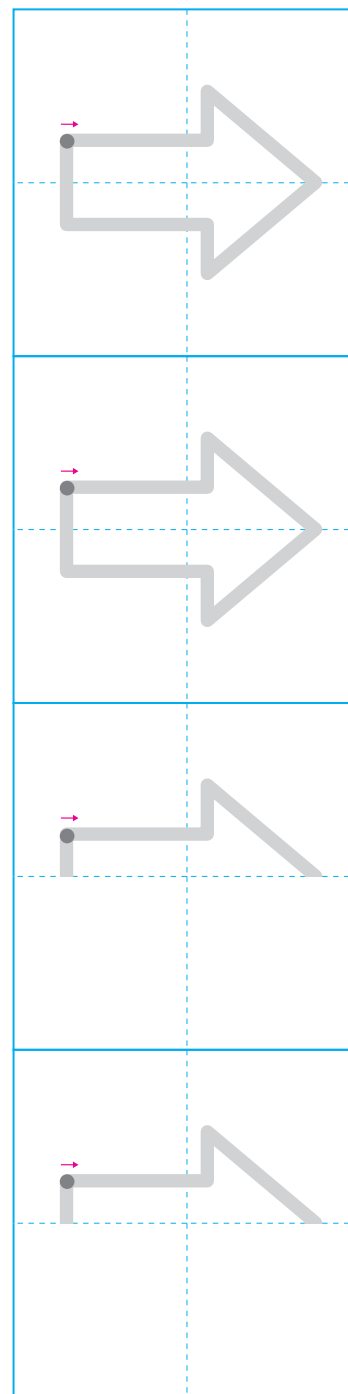
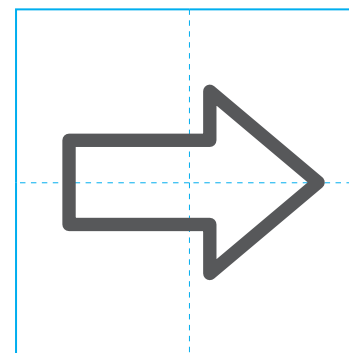
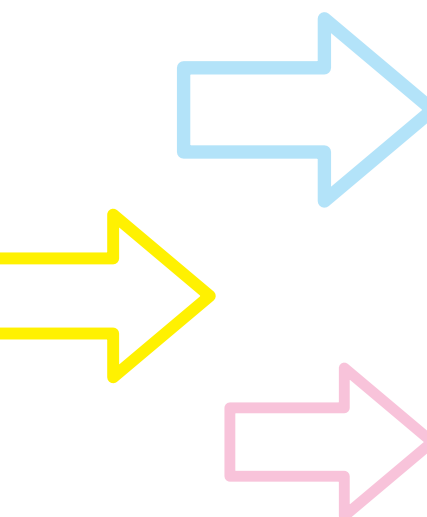

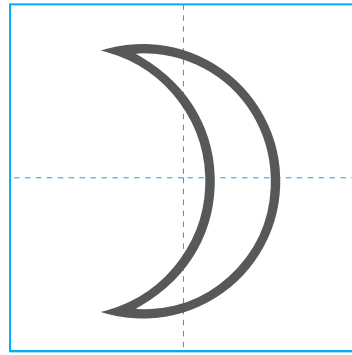
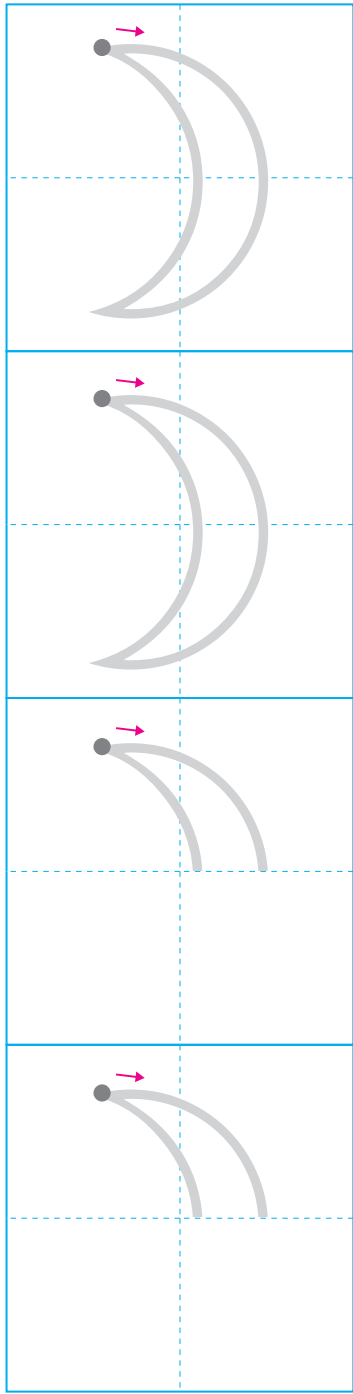
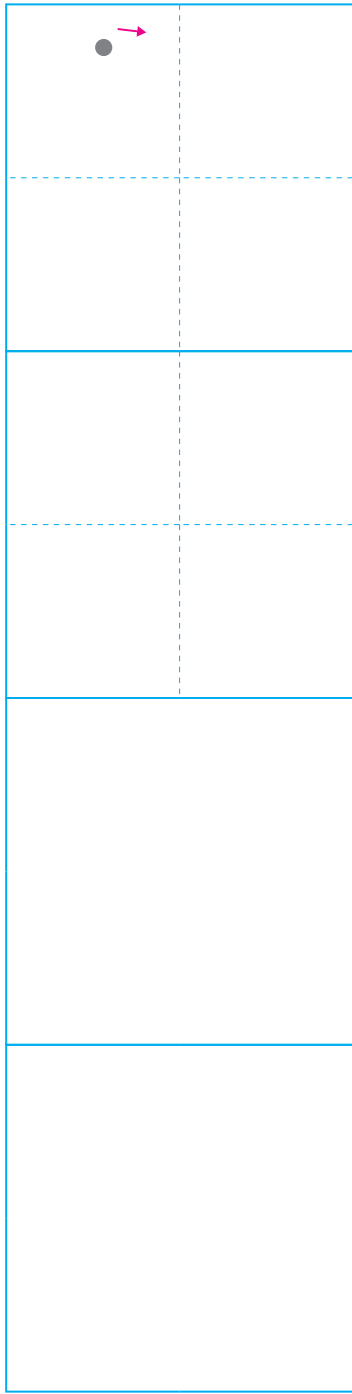

か (みかづき) を かきましよう。



なまえ

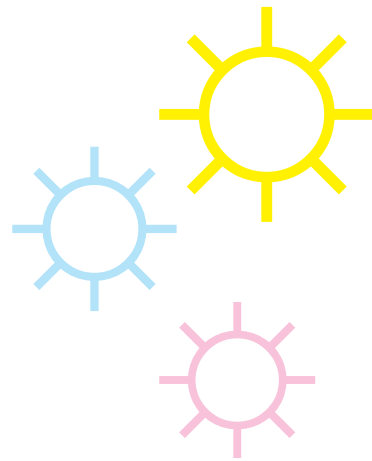
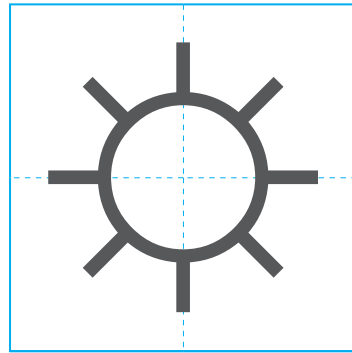
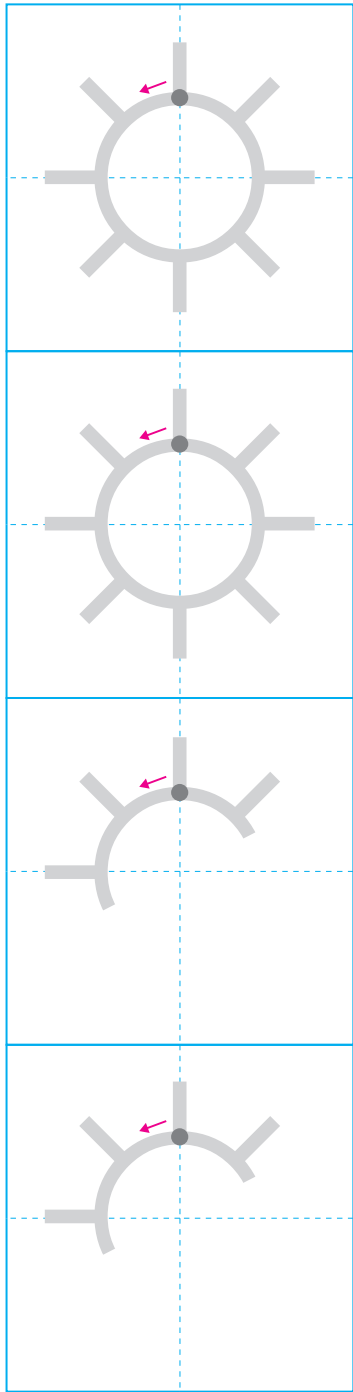
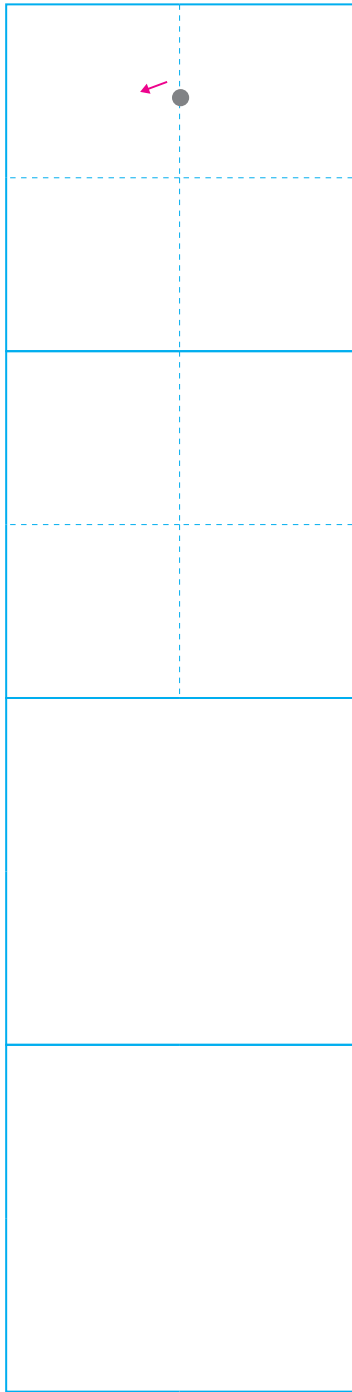

 おひさま(おひさま)をかきましょう。



なまえ